

DIE LUST ZU BAUEN  
L'ENVIE DE CONSTRUIRE

# Saneo Elegance *Quadrate*

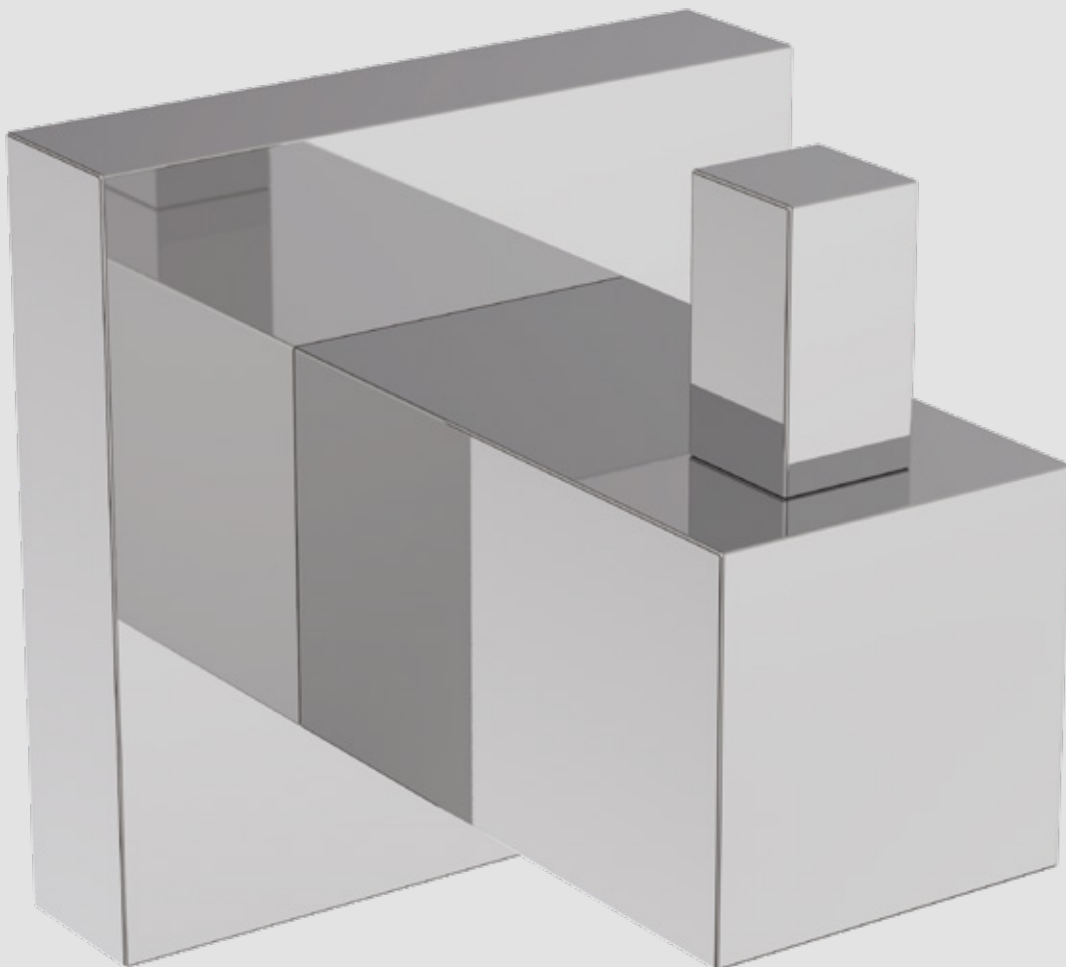

# SANEO ELEGANCE QUADRATE

Dimensions en mm (largeur x profondeur x hauteur) / Masse in mm (Breite x Tiefe x Höhe)



**ART. 591385**  
64 x 97 x 107 mm



**ART. 591386**  
1763 x 93 x 107 mm



**ART. 591387**  
103 x 117 x 50 mm



**ART. 591388**  
69 x 117 x 52 mm



**ART. 591389**  
892 x 126 x 350 mm



**ART. 591390**  
81 x 105 x 405 mm



**ART. 591391**  
145 x 66 x 155 mm

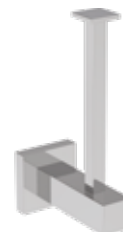

**ART. 591392**  
45 x 90 x 157 mm



**ART. 591393**  
500 x 135 x 45 mm



**ART. 591394**  
495 x 80 x 45 mm



**ART. 591395**  
645 x 80 x 45 mm



**ART. 591396**  
845 x 80 x 48 mm

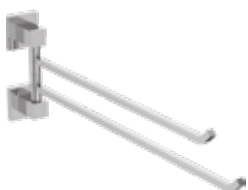

**ART. 591397**  
45 x 455 x 144 mm



**ART. 591398**  
217 x 66 x 155 mm

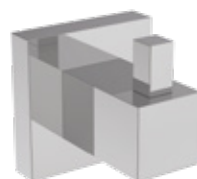

**ART. 591403**  
45 x 48 x 45 mm



**ART. 591404**  
82 x 66 x 45 mm



**ART. 591405**  
350 x 83 x 50 mm





# Exklusiv an ausgewählten Standorten





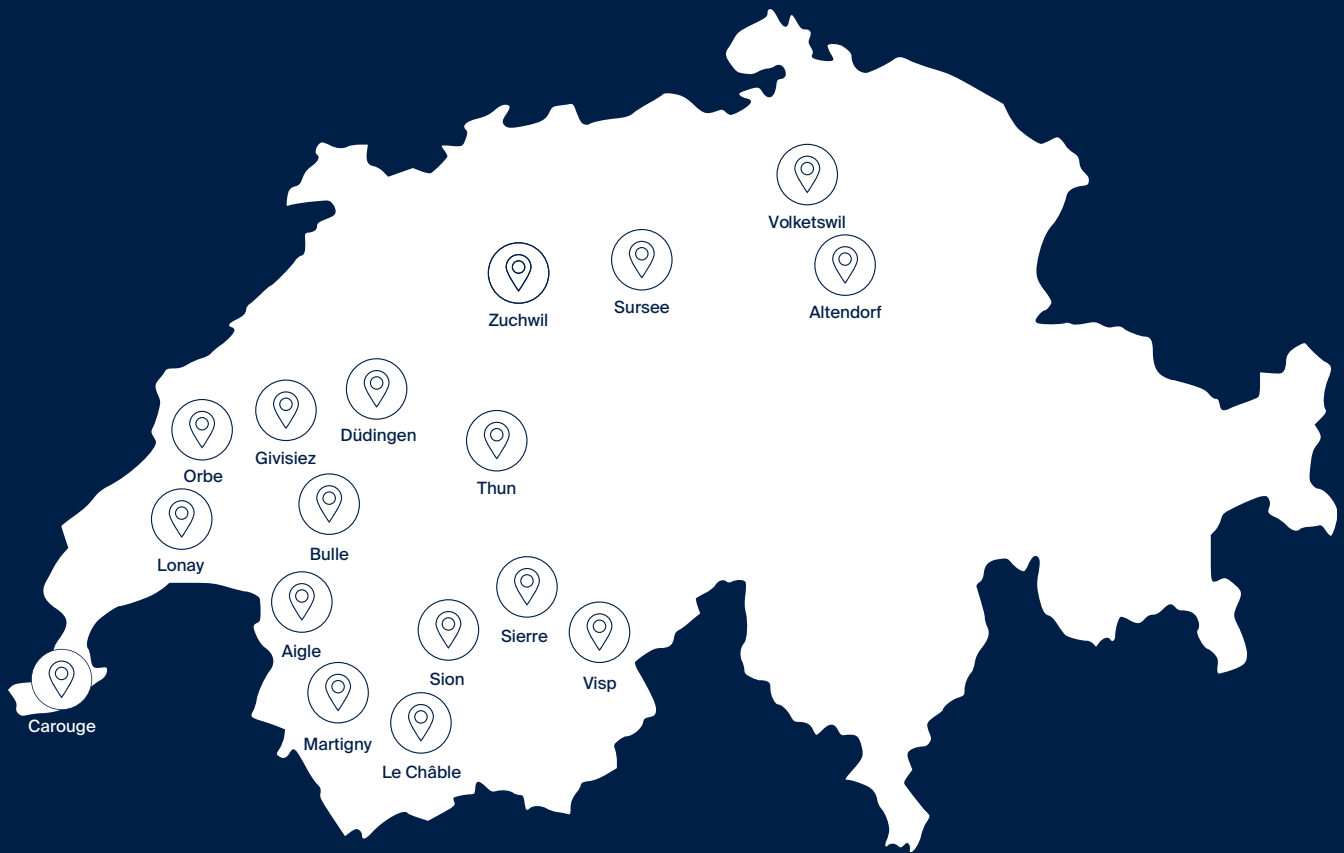

Immer auf der Suche nach den neusten Trends

# Exclusivement dans des lieux sélectionnés

Toujours à l'affut des dernières tendances



 Kompetenz-Zentrum „Leben ohne Hindernisse“  
Centre de compétence „vivre sans obstacles“

|   |                  |  Bäder<br>Salles de bain |  Wand- & Bodenbeläge<br>Revêtements mur et sol |  Küchen<br>Cuisines |  Haushaltsgeräte<br>Electroménager |  Baumaterial<br>Constructions |  Holz<br>Bois |  Werkzeuge<br>Outils |
|---|------------------|---|---|--|---|--|--|---|
| <b>Visp</b> VS                                  | +41 27 948 84 11 | ●   | ●   | ●  | ●   | ●  | ●  | ●   |
| <b>Sierre</b> VS                                | +41 27 455 33 77 | ●   | ●   |  |   |  |  | ●   |
| <b>Sion</b> VS                                  | +41 27 203 46 55 | ●   | ●   |  |   |  |  | ●   |
| <b>Le Châble</b> VS (Paul Maret SA)             | +41 27 776 13 71 |   |   |  |   | ●  | ●  | ●   |
| <b>Martigny</b> VS                              | +41 27 720 57 20 | ●   | ●   | ●  | ●   |  |  | ●   |
| <b>Aigle</b> VD                                 | +41 24 467 06 00 | ●   | ●   |  |   |  |  | ●   |
| <b>Lonay</b> VD                                 | +41 21 804 10 20 | ●   | ●   | ●  | ●   |  |  | ●   |
| <b>Orbe</b> VD                                  | +41 24 486 80 00 | ●   | ●   |  |   |  |  | ●   |
| <b>Carouge</b> GE                               | +41 22 308 09 60 | ●   | ●   |  |   |  |  | ●   |
| <b>Bulle</b> FR                                 | +41 26 919 89 60 | ●   | ●   |  | ●   | ●  | ●  | ●   |
| <b>Givisiez</b> FR                              | +41 26 404 04 00 | ●   | ●   |  |   |  |  | ●   |
| <b>Düdingen</b> FR                              | +41 26 492 52 00 | ●   | ●   |  |   |  |  | ●   |
| <b>Thun</b> BE                                  | +41 33 225 35 35 | ●   | ●   |  |   |  |  | ●   |
| <b>Zuchwil</b> SO (Tribelhorn AG)               | +41 32 686 27 27 | ●   | ●   |  |   |  |  | ●   |
| <b>Sursee</b> LU                                | +41 41 499 00 00 | ●   | ●   |  |   |  |  | ●   |
| <b>Volketswil</b> ZH                            | +41 44 403 40 00 | ●   | ●   |  |   |  |  | ●   |
| <b>Altendorf</b> SZ (Ausstellung Tribelhorn AG) | +41 32 686 27 27 | ●   | ●   |  |   |  |  | ●   |



bringhen.ch